



DIRECTIONALS



ED3700 Series

R65 Class I & II Surface Mount

These versatile surface mount lights feature high-intensity LEDs providing exceptional warning synchronisation capability and R65 Class I & II operation. Compact design, ability to fit in confined mounting locations, zero maintenance and a 5-year warranty are just some of the many benefits. Available in single, or dual-colour variants and a double stack option. A range of accessory brackets are also available to further maximize mounting options.

Features and Benefits

- 12 - 24 VDC
- Same mounting hole pattern and brackets as the 3700 series
- Single and dual-colour options with controllable flash patterns
- Synchronisable, dimmable, and steady-burn modes
- Single stack (ED3703/04/44/05/55) Double stack (ED3788/89)
- Polycarbonate lens and waterproof housing ensure extended life
- Temperature Range: -40°C to +65°C (-40°F to +149°F)
- The ED3700 series can be synchronised with the following other ECCO directionals, ED9040, ED3766, ED3706, ED3712, ED3701, ED3702, ED3700 & ED3777.

Models

PART NO.	TYPE	FLASH PATTERNS	COLOUR	R65 APPROVALS
ED3703A	3 LED	21	Orange	R65 Class I
XTP3B	3 LED	21	Blue	R65 Class I
XTP3W	3 LED	21	White	-
ED3703G	3 LED	21	Green	-
XTP3R	3 LED	21	Red	R65 Class II
ED3704A	4 LED	30	Orange	R65 Class II
XTP4BB	4 LED	30	Blue	R65 Class II
XTP4WW	4 LED	30	White	-
ED3704G	4 LED	30	Green	-
XTP4RR	4 LED	30	Red	R65 Class II

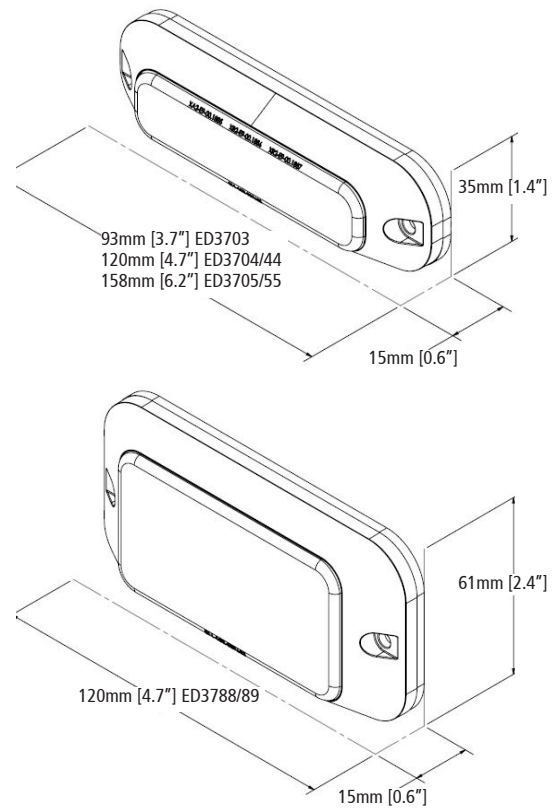





































Accessories

- Black Bezel (included with product)
- 90° Bracket
- Grommet flush mount bezel
- Grille Bracket

+44 (0)113 237 5340 | sales@eccogroup.com

Models (Continued)

ED3705A	6 LED	30		R65 Class II
XTP6BB	6 LED	30		R65 Class II
XTP6WW	6 LED	30		-
ED3705G	6 LED	30		-
XTP6RR	6 LED	30		R65 Class II
ED3744AC	8 LED	-		R65 Class II 
XTP4MCBA	8 LED	70		R65 Class II  Class I 
XTP4MCRA	8 LED	70		R65 Class II
XTP4MCBW	8 LED	70		R65 Class I 
XTP4MCRB	8 LED	70		R65 Class II  Class I 
XTP4MCRW	8 LED	70		R65 Class II 
ED3755AC	12 LED	-		R65 Class II 
XTP6MCBA	12 LED	70		R65 Class II
XTP6MCRA	12 LED	70		R65 Class II
XTP6MCBW	12 LED	70		R65 Class II 
XTP6MCRB	12 LED	70		R65 Class II
XTP6MCRW	12 LED	70		R65 Class II
ED3788A	8 LED	62		R65** Class II
XTP4DSBB	8 LED	62		R65** Class II
XTP4DSWW	8 LED	62		-
XTP4DSRR	8 LED	62		R65** Class II
ED3789AC	16 LED	70		R65** Class II
XTP4DSMCBA	16 LED	70		R65** Class II
XTP4DSMCBW	16 LED	70		R65** Class II
XTP4DSMCRA	16 LED	70		R65** Class II
XTP4DSMCRB	16 LED	70		R65** Class II
XTP4DSMCRW	16 LED	70		R65** Class II

Accessories (Continued)

ACCESSORY	MOUNT
USE WITH: ED3703 or XTP3	
CZXP3BZL	Black bezel kit
XTP3CHMBZ	Chrome plated bezel
XT3GRL	Bolt on grill bracket
XT3LBKT	Aluminium, painted black bracket
XTP3RUBZ	Black rubber bezel
USE WITH: ED3704, ED3744 or XTP4	
CZXP4BZL	Black bezel kit
XTP4CHMBZ	Chrome plated bezel
XT4GRL	Bolt on grill bracket
XT4LBKT	Aluminium, painted black bracket
XTP4RUBZ	Black rubber bezel
USE WITH: ED3705, ED3755 or XTP6	
CZXP6BZL	Black bezel kit
XTP6CHMBZ	Chrome plated, screw mount
XT6GRL	Bolt on grill bracket
XT6LBKT	Aluminium, painted black bracket
XTP6RUBZ	Black rubber bezel
USE WITH: ED3788 or XTP4DS, ED3789 or XTP4DSMC	
CZXP4DSBZL	Black bezel kit

