

## L52 2C

Thank you for choosing a product from Standby.

### Technical Data

Lens	Polycarbonate
Diodes	6+6 high power LED
Cable	2 m, basic version
Power	10-30 V DC
Ambient temperature	-40°C to +85°C
Power consumption	0.8 A peak at 13.8 V 0.4 A peak at 27.6 V
Size	113 x 28 x 9 mm
Approvals	Light: ECE R65 (E5) EMC: ECE R10 (E5) IP6K9K
Included	1 x L52 Lamp 2C 1 x gasket 1 x assembly kit
Synchronizing	12 V: Up to 12 lamps 24 V: Up to 8 lamps

### Preset Settings

Part number	Color 1	Color 2	Flash pattern		Sync mode		Input X2/X3	
			Color 1	Color 2	Color 1	Color 2	Color 1	Color 2
45257031	Blue	Amber	Double	Double	Simultaneous	Alternate	Pull down	Pull down
45257032	Blue	Red		Steady				
45257033	Blue	White		Steady				
45257034	Blue	Green		Double				
45267031	Red	White		Double				
45287031	Amber	White		Steady				
45287032	Green	Amber		Double				
45287034	Amber	Red		Steady				

To change the flash pattern setting, see Flash Pattern. To change the sync mode setting, see Sync Mode. To change the input X2/X3 setting, see Input X2/X3.

Flash Pattern

**Introduction**

The flash pattern setting controls the flash pattern. There are seven available combinations of flash patterns, see table.

- **Double, Triple** and **Steady burn** are built-in flash patterns and no control system is needed.
- With **Steady burn 1, Steady burn 2** and **Steady burn 3** an external flasher or control system is used to control the flash pattern.

The preset setting of flash pattern depends on the version of the lamp, see [Preset Settings](#).

When in configuration mode, the number of **blank** flashes (lamp off) in the flash sequence show the current flash pattern setting, see table.

Blank flashes per flash sequence	Flash pattern		Flash control
	Color 1	Color 2	
1	Double	Double	Built-in
2	Triple	Triple	Built-in
3	Double	Steady burn	Built-in
4	Triple	Steady burn	Built-in
5	Steady burn 1	Steady burn 1	External
6	Steady burn 2	Steady burn 2	External
7	Double	Steady burn 3	Built-in/External

Setting the Flash Pattern

**! WARNING**

Risk of eye damage. Do not look into the beam at close range.

1. If already in configuration mode, go to step 6.
2. If the lamp is connected to the power supply, disconnect it.
3. Connect the red wire to 10-30 V DC via a 5 A fuse.

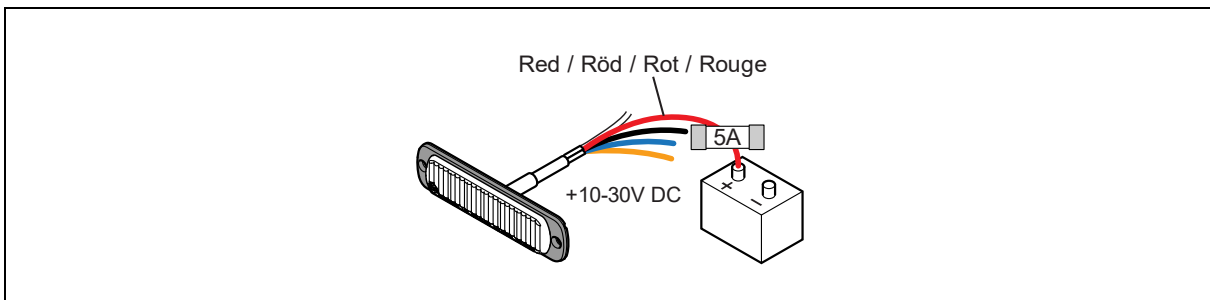

4. Connect the black wire to ground.

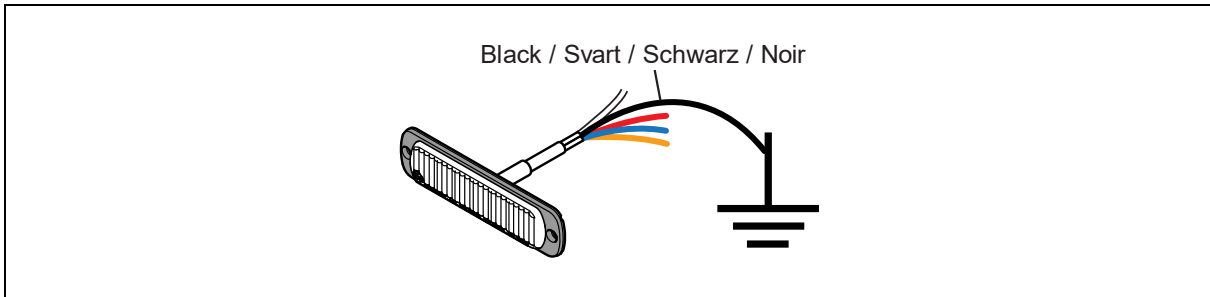

5. Within 1 to 6 sec: temporarily connect the white wire to ground and let it stay connected for at least 2 sec.

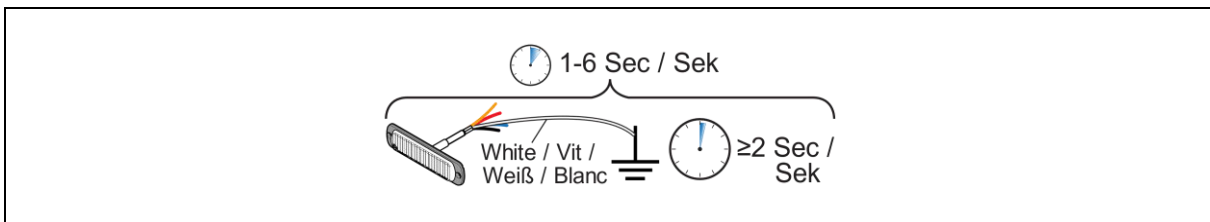

The lamp enters configuration mode and a flash sequence indicating the current settings starts.

**! Note**

If this step is performed incorrectly, you must restart from step 2.

6. Temporarily connect the white wire to ground to enter configuration mode for flash pattern.

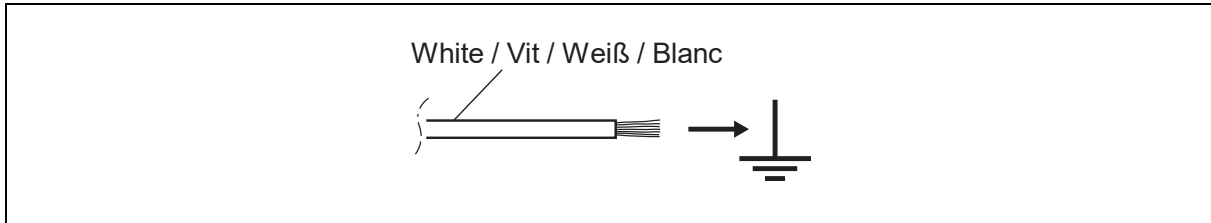

7. Count the number of blank flashes (lamp off) per flash sequence to find out the current flash pattern setting.

8. Temporarily connect the white wire to ground to change to the next version of flash pattern. Each time the white wire is temporarily connected to ground the next version of flash pattern is selected.

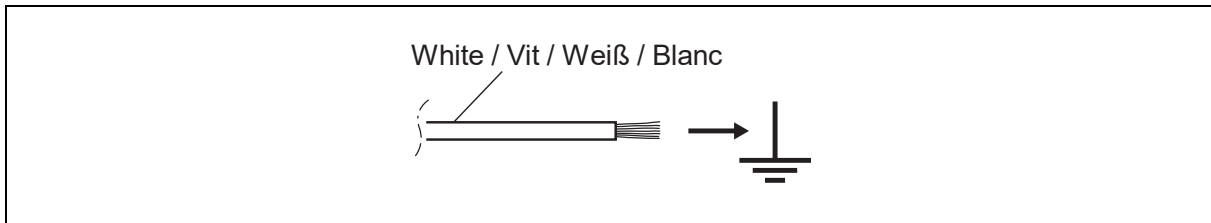

9. To change the sync mode setting, see [Sync Mode](#). To change the input X2/X3 setting, see [Input X2/X3](#). To reset to factory settings, see [Factory Reset](#).

10. Disconnect the power supply to save the selected settings and exit configuration mode.

---

## Sync Mode

### Introduction

The sync mode setting controls how the flashing of two or more lamps is synchronized. There are four available combinations of sync mode, see table.

- **Simultaneous** means that the lamps are in sync, that is they come on and go off at the same time.
- **Alternate** means that the lamps are out of sync.

The preset setting of sync mode is Simultaneous for color 1 and Alternate for color 2.

When in configuration mode, the number of **bright** flashes of color 1 per flash sequence show the current sync mode setting, see table.

Bright flashes (color 1) per flash sequence	Sync mode	
	Color 1	Color 2
1	Simultaneous	Alternate
2	Alternate	Simultaneous
3	Alternate	Alternate
4	Simultaneous	Simultaneous

**Setting the Sync Mode**

**! WARNING**

Risk of eye damage. Do not look into the beam at close range.

1. If already in configuration mode, go to step 6.
2. If the lamp is connected to the power supply, disconnect it.
3. Connect the red wire to 10-30 V DC via a 5 A fuse.

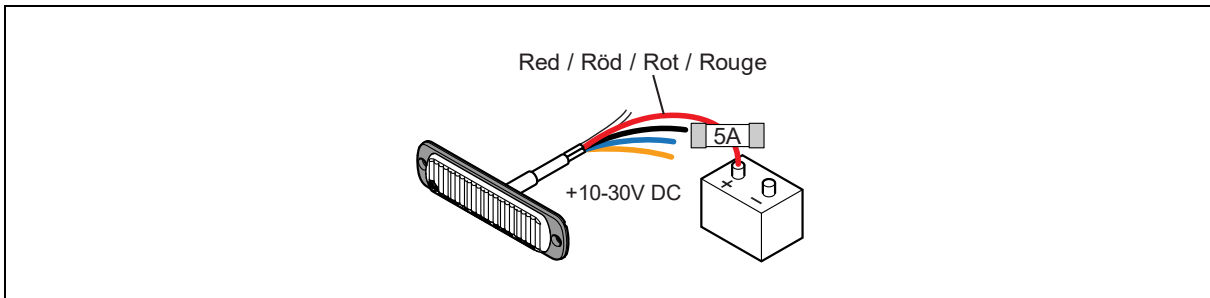

4. Connect the black wire to ground.

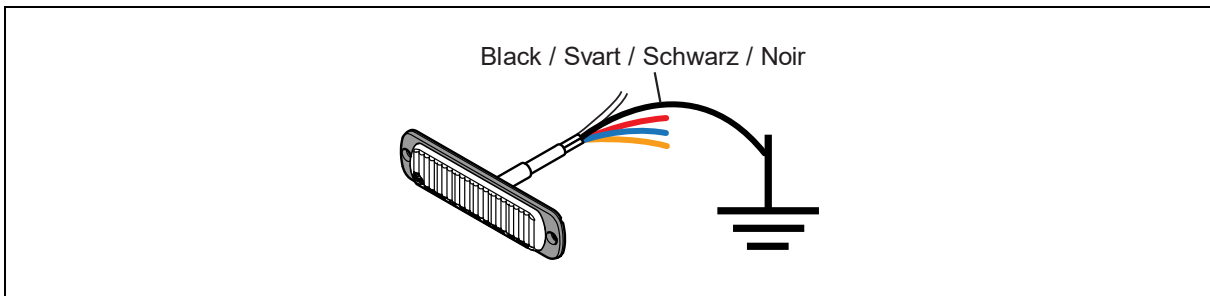

5. Within 1 to 6 sec: temporarily connect the white wire to ground and let it stay connected for at least 2 sec.

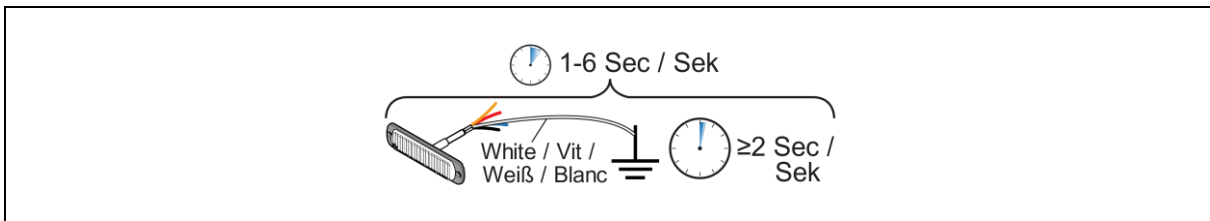

The lamp enters configuration mode and a flash sequence indicating the current settings starts.

**! Note**

If this step is performed incorrectly, you must restart from step 2.

6. Temporarily connect the blue wire to ground to enter configuration mode for sync mode.

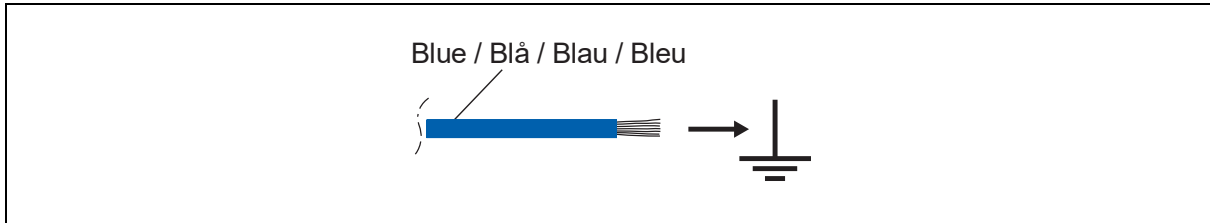

7. Count the number of bright flashes of color 1 per flash sequence to find out the current sync mode setting.

8. Temporarily connect the blue wire to ground again to change to the next version of sync mode. Each time the blue wire is temporarily connected to ground the next version of sync mode is selected.

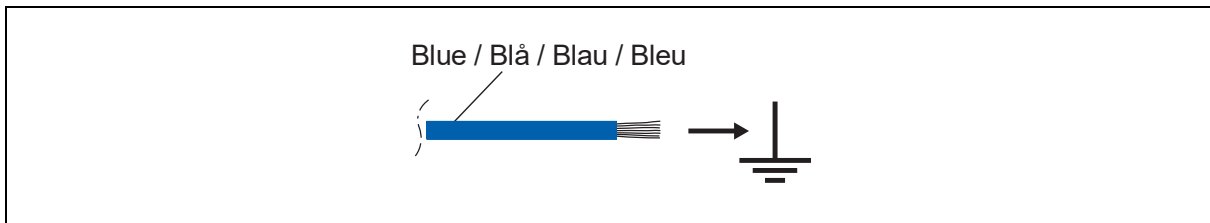

9. To change the flash pattern setting, see [Flash Pattern](#). To change the input X2/X3 setting, see [Input X2/X3](#). To reset to factory settings, see [Factory Reset](#).

10. Disconnect the power supply to save the selected settings and exit configuration mode.

Input X2/X3

**Introduction**

The input X2/X3 controls how the colors of the lamp are activated. There are four available combinations of input X2/X3, see table.

- **Pull down** means that the color is activated by a sourcing signal (+).
- **Pull up** means that the color is activated by a sinking signal (-).

The preset setting of input X2/X3 mode is Pull Down for both color 1 and color 2.

When in configuration mode, the number of **bright** flashes of color 2 in the flash sequence show the current input X2/X3 setting, see table.

Bright flashes (color 2) per flash sequence	Input X2/X3	
	Color 1	Color 2
1	Pull down	Pull down
2	Pull up	Pull up
3	Pull down	Pull up
4	Pull up	Pull down

**Setting the Input X2/X3**

**! WARNING**

Risk of eye damage. Do not look into the beam at close range.

1. If already in configuration mode, go to step 6.
2. If the lamp is connected to the power supply, disconnect it.
3. Connect the red wire to 10-30 V DC via a 5 A fuse.

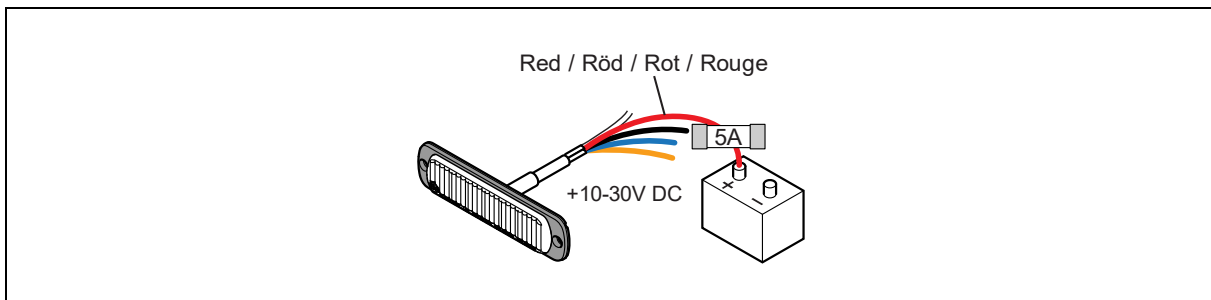

4. Connect the black wire to ground.

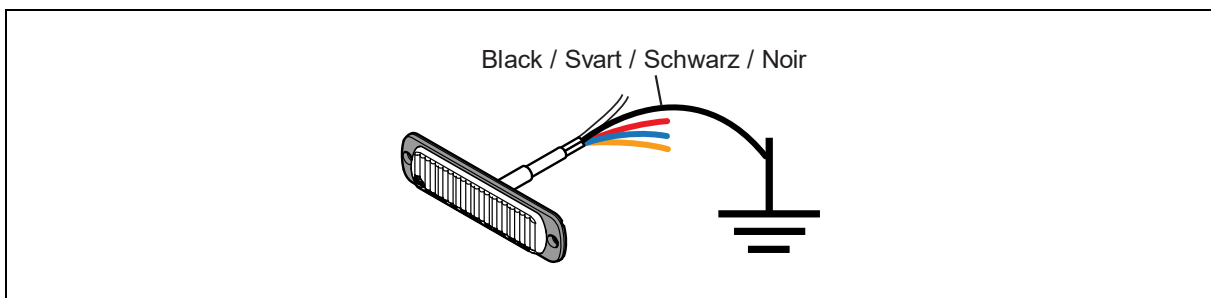

5. Within 1 to 6 sec: temporarily connect the white wire to ground and let it stay connected for at least 2 sec.

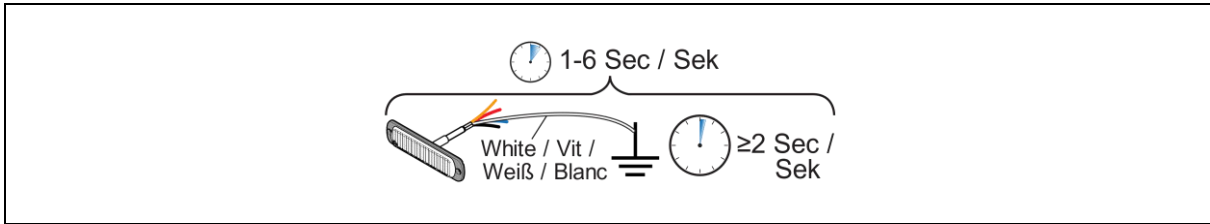

The lamp enters configuration mode and a flash sequence indicating the current settings starts.

**! Note**

If this step is performed incorrectly, you must restart from step 2.

6. Temporarily connect the orange wire to ground to enter configuration mode for input X2/X3.

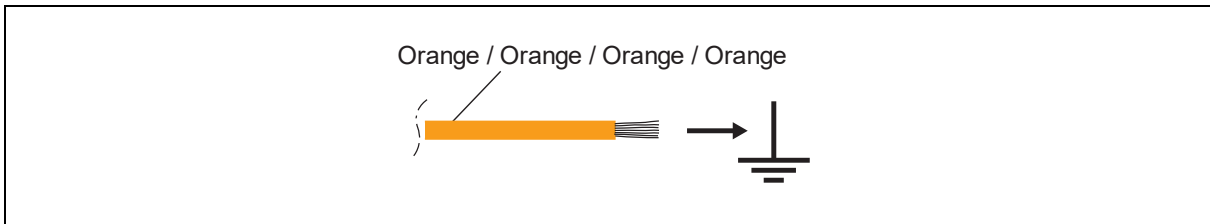

7. Count the number of bright flashes of color 2 to find out the current input X2/X3 setting.

8. Temporarily connect the orange wire to ground again to change to the next version of input X2/X3. Each time the orange wire is connected to ground the next version of input X2/X3 is selected.

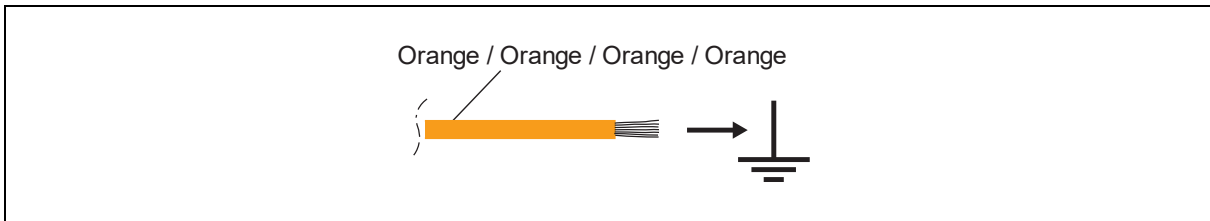

9. To change the flash pattern setting, see [Flash Pattern](#). To change the sync mode setting, see [Sync Mode](#). To reset to factory settings, see [Factory Reset](#).

10. Disconnect the power supply to save the selected settings and exit configuration mode.

## Factory Reset

### Introduction

The settings can be changed back to the factory settings.

The factory settings are the following(color 1/color 2):

- Flash pattern - Double/Double
- Sync mode - Simultaneous/Alternate
- Input X2/X3 - Pull down/pull down

### Reset to Factory Settings

#### ! WARNING

Risk of eye damage. Do not look into the beam at close range.

#### ! Note

All current settings, that is flash pattern setting, sync mode setting and Input X2/X3, are reset to the default settings.

1. If already in configuration mode, go to step 6.
2. If the lamp is connected to the power supply, disconnect it.
3. Connect the red wire to 10-30 V DC via a 5 A fuse.

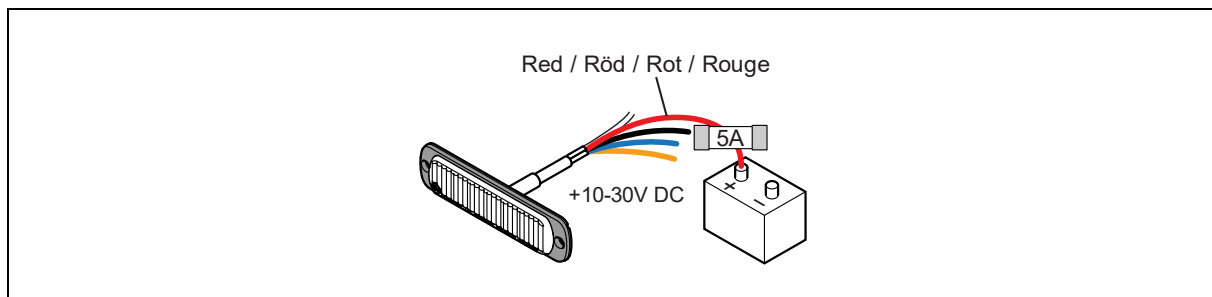

4. Connect the black wire to ground.

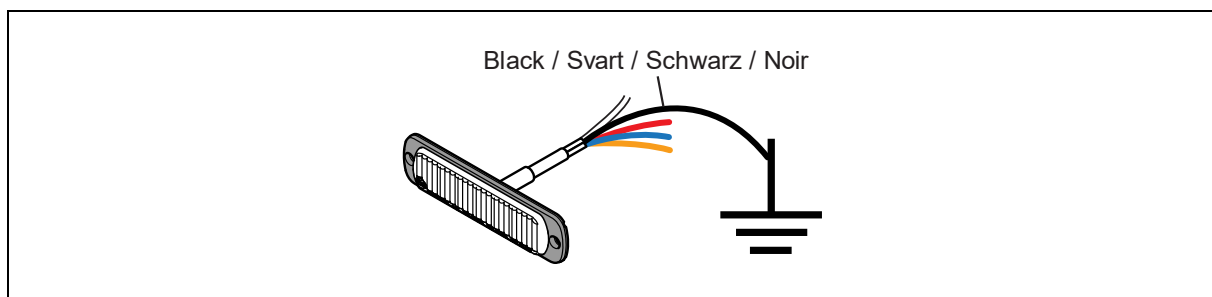

5. Within 1 to 6 sec: temporarily connect the white wire to ground and let it stay connected for at least 2 sec.

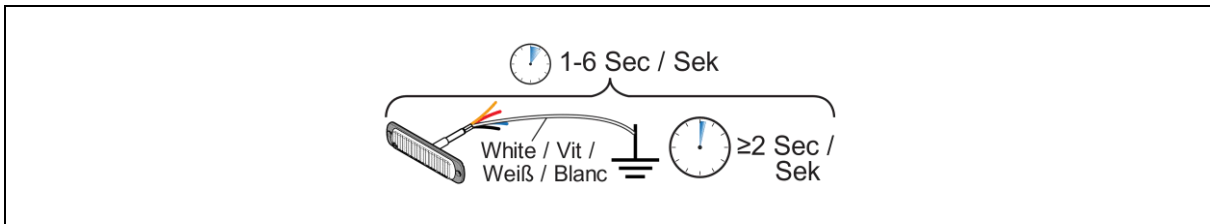

The lamp enters configuration mode and a flash sequence indicating the current settings starts.

**! Note**

If this step is performed incorrectly, you must restart from step 2.

6. Connect the **BLUE** and the **WHITE** wire to ground and let them stay connected for at least 2 seconds.

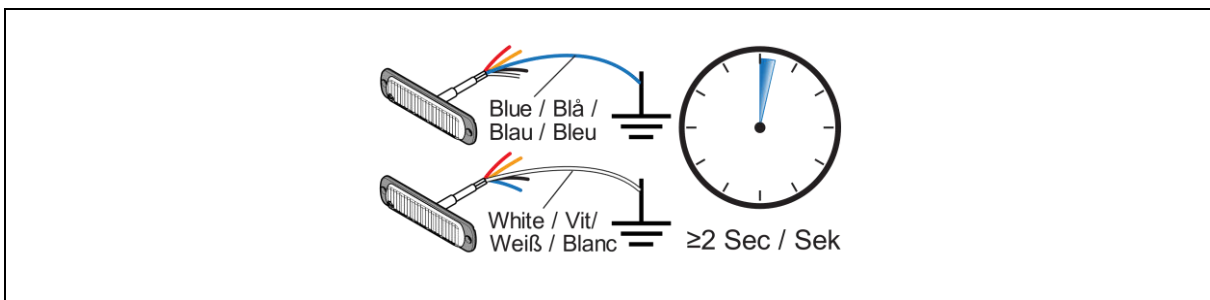

7. The reset is confirmed with a bright steady light for 2-3 seconds.

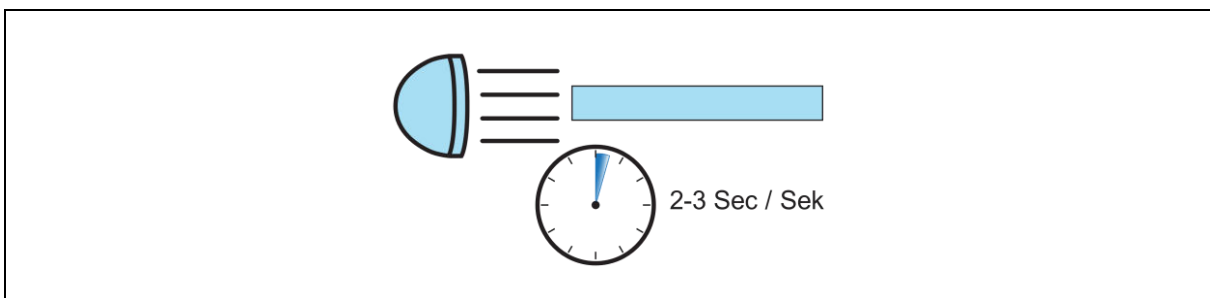

**Connections**

The function of each wire and how to connect the wires depend on which version of flash pattern and input X2/X3 that is selected, see tables below.

For more information about flash pattern and input X2/X3, see [Flash Pattern](#) and [Input X2/X3](#).

**Table 1. Connections when flash pattern Double/Double, Double/Triple, Double/Steady burn or Triple/Steady burn is selected.**

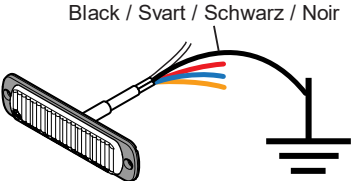
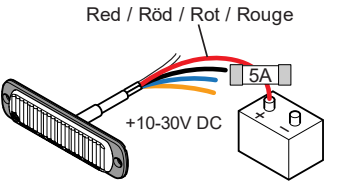
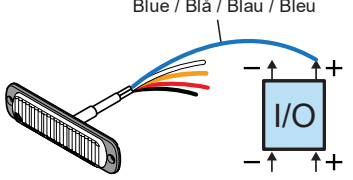
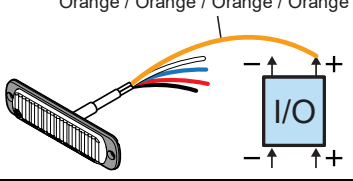
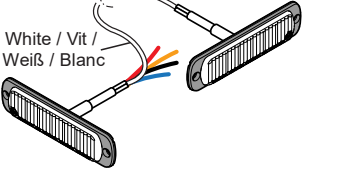
Wire	Functions	Connect to	
<b>Black</b>	Power supply	Good and suitable ground	<p>Black / Svart / Schwarz / Noir</p> 
<b>Red</b>	Power supply	10-30 V DC via a 5 A fuse	<p>Red / Röd / Rot / Rouge</p> 
<b>Blue</b>	Activates the flashing of color 1	Sourcing output (+) of an I/O unit*	<p>Blue / Blå / Blau / Bleu</p> 
<b>Orange</b>	Activates the flashing of color 2	Sourcing output (+) of an I/O unit**	<p>Orange / Orange / Orange / Orange</p> 
<b>White</b>	Synchronizes the flashing of two or more lamps	Sync cable of the other lamps	<p>White / Vit / Weiß / Blanc</p> 

**Table 2. Connections when flash pattern Steady burn 1/Steady burn 1 is selected.**

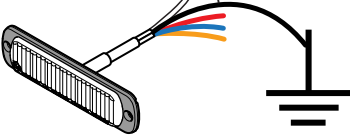
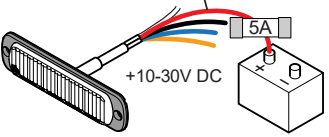
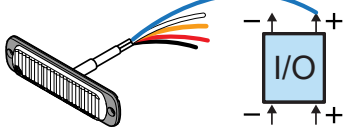
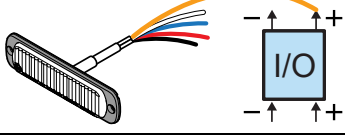
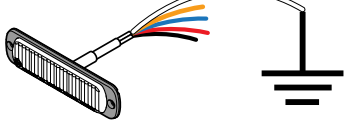
Wire	Functions	Connect to	
<b>Black</b>	Power supply	Good and suitable ground	<p>Black / Svart / Schwarz / Noir</p> 
<b>Red</b>	Power supply	10-30 V DC via a 5 A fuse	<p>Red / Röd / Rot / Rouge</p> 
<b>Blue</b>	Activating Steady burn for color 1	Sourcing output (+) of an I/O unit*	<p>Blue / Blå / Blau / Bleu</p> 
<b>Orange</b>	Activating Steady burn for color 2	Sourcing output (+) of an I/O unit**	<p>Orange / Orange / Orange / Orange</p> 
<b>White</b>	Change color 1 from Steady burn to Double Change color 2 from Steady burn to Double	Ground when color 1 is active Ground when color 2 is active	<p>White / Vit / Weiß / Blanc</p> 

**Table 3. Connections when flash pattern Steady burn 2/Steady burn 2 is selected.**

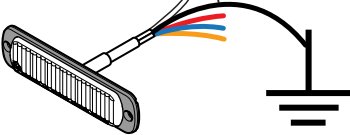
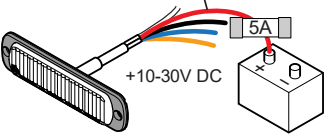
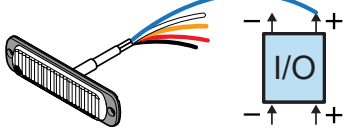
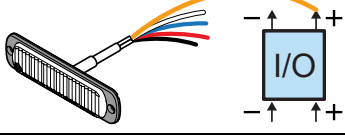
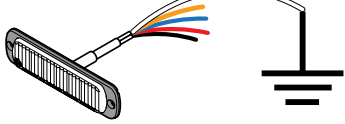
Wire	Functions	Connect to	
<b>Black</b>	Power supply	Good and suitable ground	<p>Black / Svart / Schwarz / Noir</p> 
<b>Red</b>	Power supply	10-30 V DC via a 5 A fuse	<p>Red / Röd / Rot / Rouge</p> 
<b>Blue</b>	Activating Steady burn for color 1	Sourcing output (+) of an I/O unit*	<p>Blue / Blå / Blau / Bleu</p> 
<b>Orange</b>	Activating Steady burn for color 2	Sourcing output (+) of an I/O unit**	<p>Orange / Orange / Orange / Orange</p> 
<b>White</b>	Change color 1 from Steady burn to Triple  Change color 2 from Steady burn to Triple	Ground when color 1 is active  Ground when color 2 is active	<p>White / Vit / Weiß / Blanc</p> 

**Table 4. Connections when flash pattern Double/Steady burn 3 is selected.**

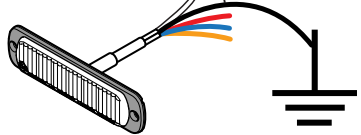
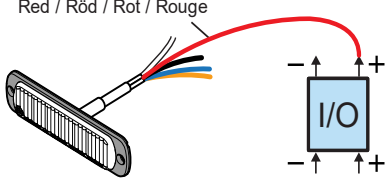
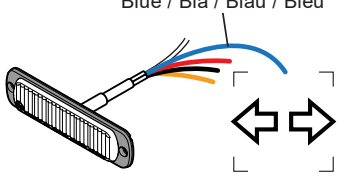
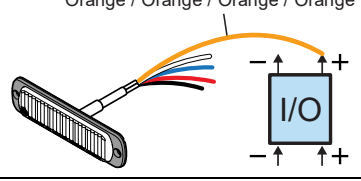
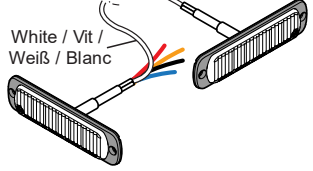
Wire	Functions	Connect to	
<b>Black</b>	Power supply	Good and suitable ground	Black / Svart / Schwarz / Noir 
<b>Red</b>	Power supply  Activating the flashing of color 1	10-30 V DC via a 5 A fuse  Sourcing (+) output of an I/O unit	Red / Röd / Rot / Rouge 
<b>Blue</b>	Activating Steady burn for color 2	Direction-indicator control system or sourcing output (+) of an I/O unit	Blue / Blå / Blau / Bleu 
<b>Orange</b>	Change from color 1 to color 2	Sourcing output (+) of an I/O unit	Orange / Orange / Orange / Orange 
<b>White</b>	Synchronizing the flashing of two or more lamps	Sync cable of the other lamps	White / Vit / Weiß / Blanc 

\* If input X2/X3 for color 1 is Pull down. If not, connect the wire to a sinking output (-) of an I/O unit.

\*\* If input X2/X3 for color 2 is Pull down. If not, connect the wire to a sinking output (-) of an I/O unit.

Installation

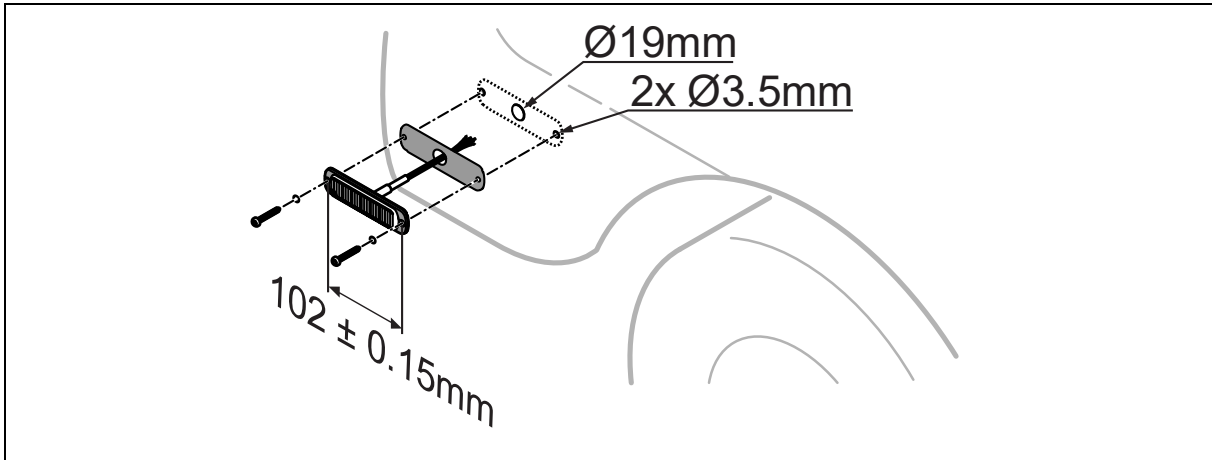

**! CAUTION**

The lamp must be mounted on a flat surface.

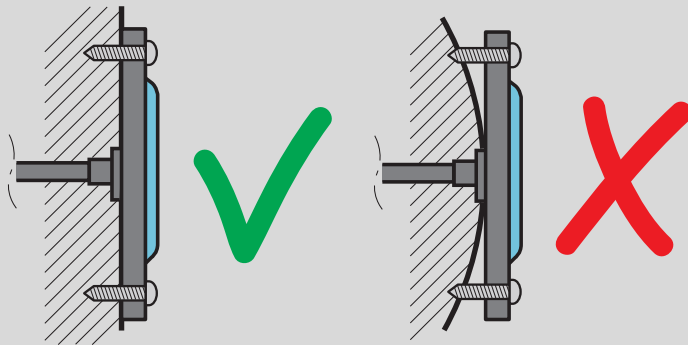

To prevent moisture from entering the lamp through the cable end, make sure that the cable end is sealed or located in a dry part of the vehicle.

When using a pressure washer, keep a minimum distance of 40 cm.

